

Test Booklet No.

Subject : PHYSICS

Test Booklet Code

Code : 322 E

Medium : English



(Do not open this Test Booklet until you are asked to do so)

Time Allowed : 60 minutes

Maximum Marks : 200

Total Questions : 50

Number of questions to be answered : 40

Kindly read the Instructions given on this Page and Back Page carefully before attempting this Question Paper.

Important Instructions for the Candidates :

1. This Test Booklet contains **50** questions printed in English. Out of these, the candidate is required to answer any **40** questions. If a candidate answers more than 40 questions, the first 40 answered questions will be considered for evaluation.
2. The OMR Answer Sheet is inside this Test Booklet. When you are directed to open the Test Booklet, take out the OMR Answer Sheet and fill in your particulars carefully with **blue/black** ball point pen only.
3. Use only Blue/Black Ball Point Pen for marking responses.
4. The CODE for this Test Booklet is **B**. Make sure that the CODE printed on the OMR Answer Sheet is the same as that on this Test Booklet. Also ensure that your Test Booklet No. and OMR Answer Sheet No. are exactly the same. In case of discrepancy, the candidate should immediately report the matter to the Invigilator for replacement of both the Test Booklet and the OMR Answer Sheet. No claim in this regard will be entertained after five minutes from the start of the examination.
5. Before attempting the question paper kindly check that this Test Booklet has total **16** pages and OMR Answer Sheet consists of one sheet. At the start of the examination within the first five minutes, candidates are advised to ensure that all pages of Test Booklet and OMR Answer Sheet are properly printed and they are not damaged in any manner.
6. Each question has four answer options. Out of these four options choose the **MOST APPROPRIATE OPTION** and darken/blacken the corresponding circle on the OMR Answer Sheet with a Blue/Black Ball Point Pen.
7. Five (5) marks will be given for each correct answer. One (1) mark will be deducted for each incorrect answer. If more than one circle is found darkened/blackened for a question, then it will be considered as an incorrect answer. Unanswered questions will be given no mark.

Name of the Candidate (in Capital Letters) : _____

Application Number (in figures) : _____

Roll Number (in figures) : _____

Centre of Examination (in Capital Letters) : _____

Candidate's Signature : _____ Invigilator's Signature : _____

Facsimile signature stamp of Centre Superintendent : _____

1. In an electromagnetic wave, the ratio of energy densities of electric and magnetic fields is _____.
Fill in the blank with the correct answer from the options given below.

(1) 1 : 1 (2) 1 : c (3) c : 1 (4) 1 : c²

2. Match List-I has four graphs showing variation of opposition to flow of ac versus frequency with circuit characteristic in List-II.

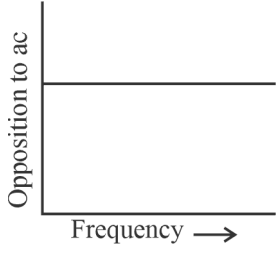
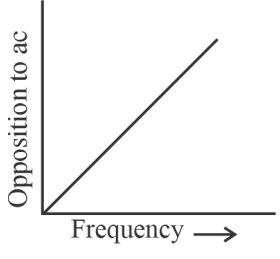
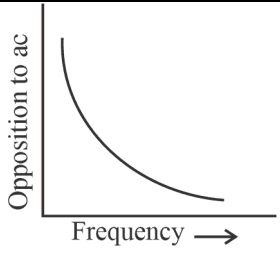
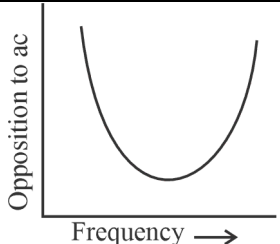
List-I	List-II
(A) 	(I) Impedance
(B) 	(II) Capacitive reactance
(C) 	(III) Inductive reactance
(D) 	(IV) Resistance

Choose the correct answer from the options given below.

- (1) (A) - (I), (B) - (II), (C) - (III), (D) - (IV) (2) (A) - (IV), (B) - (III), (C) - (II), (D) - (I)
 (3) (A) - (I), (B) - (II), (C) - (IV), (D) - (III) (4) (A) - (III), (B) - (IV), (C) - (I), (D) - (II)

SPACE FOR ROUGH WORK

3. Of the following, the correct arrangement of electromagnetic spectrum in decreasing order of wavelength is _____.

Fill in the blank with the correct answer from the options given below.

- (1) Radio waves, X-rays, Infrared waves, microwaves, visible waves
- (2) Infrared waves, microwaves, Radio waves, X-rays, visible waves
- (3) Radio waves, microwaves, Infrared waves, visible waves, X-rays
- (4) X-rays, visible waves, Infrared waves, microwaves, Radio waves

4. Match Electromagnetic waves listed in column I with Production method/device in column II.

Column-I Electromagnetic waves	Column-II Production method/device
(A) Microwaves	(I) LC oscillator
(B) Infrared	(II) Magnetron
(C) X-rays	(III) Vibration of atoms/molecules
(D) Radio waves	(IV) Bombarding large atomic number metal target with fast moving electrons

The correctly matched combination is as in option :

- (1) (A) - (I), (B) - (II), (C) - (III), (D) - (IV)
 - (2) (A) - (II), (B) - (III), (C) - (IV), (D) - (I)
 - (3) (A) - (II), (B) - (I), (C) - (IV), (D) - (III)
 - (4) (A) - (III), (B) - (IV), (C) - (I), (D) - (II)
5. In the figure given below, APB is a curved surface of radius of curvature 10 cm separating air and a transparent material ($\mu = 4/3$). A point object O is placed in air on the principal axis of the surface 20 cm from P. The distance of the image of O from P will be _____.

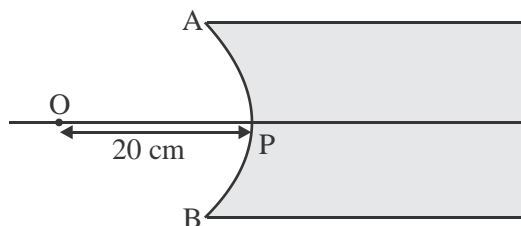

Fill in the blank with the correct answer from the options given below.

- (1) 16 cm left of P in air
- (2) 16 cm right of P in water
- (3) 20 cm right of P in water
- (4) 20 cm left of P in air

SPACE FOR ROUGH WORK

6. For fixed values of radii of curvature of lens, power of the lens will be _____.

Fill in the blank with the correct answer from the options given below.

- (1) $P \propto (\mu - 1)$ (2) $P \propto \mu^2$ (3) $P \propto 1/\mu$ (4) $P \propto \mu^{-2}$

7. The graph correctly representing the variation of image distance 'v' for a convex lens of focal length 'f' versus object distance 'u' is _____.

Fill in the blank with the correct answer from the options given below.

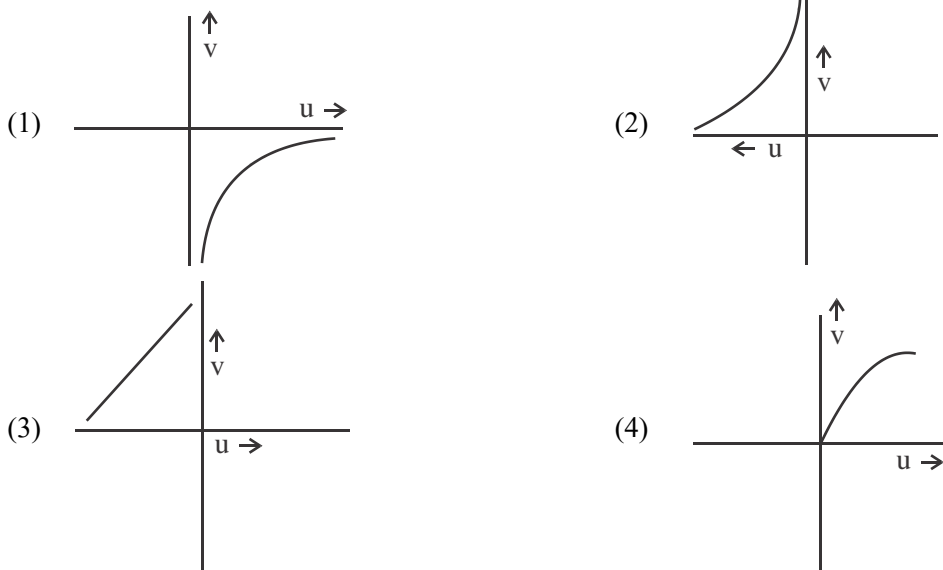

8. Using light from a monochromatic source to study diffraction in a single slit of width 0.1 mm, the linear width of central maxima is measured to be 5 mm on a screen held 50 cm away. The wavelength of light used is _____.

Fill in the blank with the correct answer from the options given below.

- (1) 2.5×10^{-7} m (2) 4×10^{-7} m
 (3) 5×10^{-7} m (4) 7.5×10^{-7} m

9. Radiation of frequency $2\nu_0$ is incident on a metal with threshold frequency ν_0 . The correct statement of the following is _____.

Fill in the blank with the correct answer from the options given below.

- (1) No photoelectrons will be emitted
 (2) All photoelectrons emitted will have kinetic energy equal to $h\nu_0$
 (3) Maximum kinetic energy of photoelectrons emitted can be $h\nu_0$
 (4) Maximum kinetic energy of photoelectrons emitted will be $2h\nu_0$

SPACE FOR ROUGH WORK

10. A point source causing photoelectric emission from a metallic plate is moved away from the plate. The variation of photoelectric current with distance from the source is correctly represented by the graph _____.

Fill in the blank with the correct answer from the options given below.

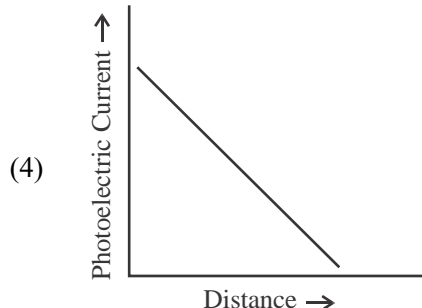
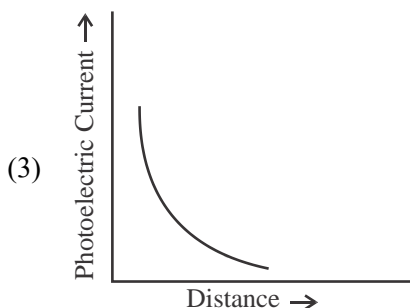
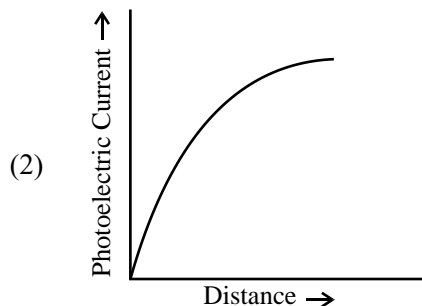
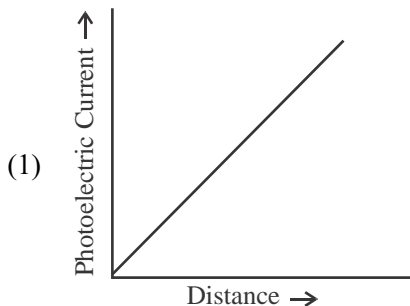

11. A proton accelerated through a potential difference V has a de Broglie wavelength λ . On doubling the accelerating potential, de Broglie wavelength of the proton _____.

Fill in the blank with the correct answer from the options given below.

- (1) remains unchanged (2) becomes double
 (3) becomes four times (4) decreases
12. The kinetic energy of an electron in ground level in hydrogen atom is K units. The values of its potential energy and total energy respectively are _____.

Fill in the blank with the correct answer from the options given below.

- (1) $-2K; -K$ (2) $+2K; -K$ (3) $-K; +2K$ (4) $+K; +2K$
13. Two nuclei have mass numbers A and B respectively. The density ratio of the nuclei is _____.

Fill in the blank with the correct answer from the options given below.

- (1) $A : B$ (2) $\sqrt{A} : \sqrt{B}$ (3) $A^2 : B^2$ (4) $1 : 1$

SPACE FOR ROUGH WORK

14. The shortest wavelengths emitted in hydrogen spectrum corresponding to different spectral series are as under :

- (A) Pfund series (B) Balmer series
 (C) Brackett series (D) Lyman series

The wavelengths arranged correctly in decreasing order are _____

Fill in the blank with the correct answer from the options given below.

- (1) (A), (B), (C), (D) (2) (A), (C), (B), (D)
 (3) (B), (A), (D), (C) (4) (A), (C), (D), (B)

15. Silicon can be doped using one of the following elements as dopant :

- (A) Arsenic (B) Indium (C) Phosphorus (D) Boron

To get n-type semiconductor, the dopants that can be used are _____.

Fill in the blank with the correct answer from the options given below.

- (1) (A) and (C) only (2) (B) and (C) only
 (3) (A), (B), (C) and (D) (4) (C) and (D) only

16. Given below are V versus I graphs for different types of p-n junction diodes marked A, B, C and D.

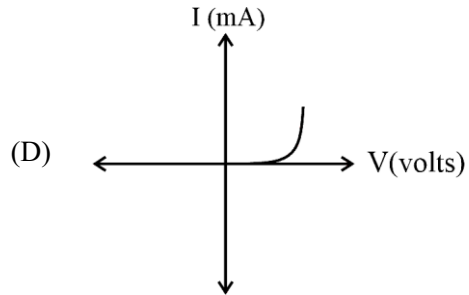
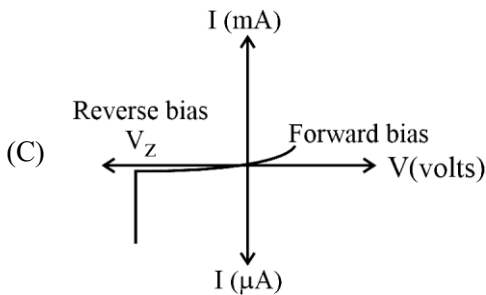
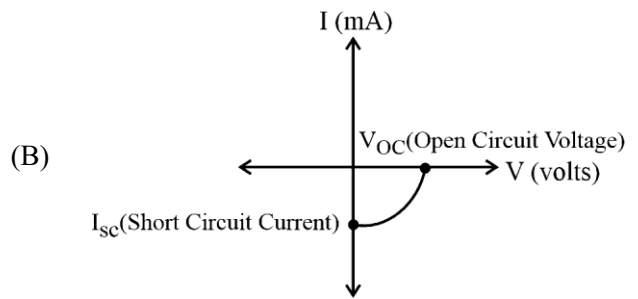
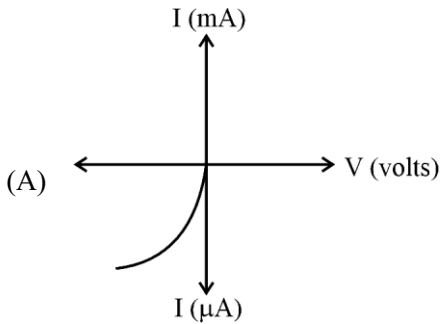

The correct sequence of graphs corresponding to forward biased p-n junction; Zener diode; Photo diode and Solar cell in order is _____

Fill in the blank with the correct answer from the options given below.

- (1) (D), (C), (A), (B) (2) (A), (C), (B), (D)
 (3) (B), (A), (D), (C) (4) (C), (B), (D), (A)

SPACE FOR ROUGH WORK

17. A wire carrying current I , bent as shown in the figure, is placed in a uniform field B that emerges normally out from the plane of the figure. The force on this wire is _____.

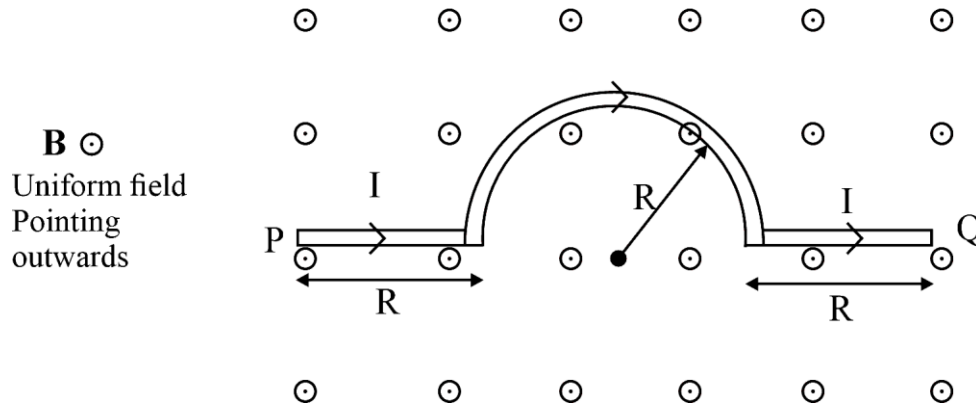

Fill in the blank with the correct answer from the options given below.

- (1) $4BIR$, directed vertically downward
 - (2) $3BIR$, directed vertically upward
 - (3) $BI(2R + \pi R)$, vertically downward
 - (4) $2\pi BIR$, from P to Q
18. The refractive index of the material of an equilateral prism is $\sqrt{2}$. The angle of minimum deviation of that prism is _____.

Fill in the blank with the correct answer from the options given below.

- (1) 60°
- (2) 75°
- (3) 30°
- (4) 90°

SPACE FOR ROUGH WORK

19. The transfer of integral number of _____ is one of the evidence of quantization of electric charge. Fill in the blank with the correct answer from the options given below.
 (1) photons (2) nuclei (3) electrons (4) neutrons
20. When a slab of insulating material 4 mm thick is introduced between the plates of a parallel plate capacitor of separation 4 mm, it is found that the distance between the plates has to be increased by 3.2 mm to restore the capacity to its original value. The dielectric constant of the material is _____.
 Fill in the blank with the correct answer from the options given below.
 (1) 2 (2) 5 (3) 3 (4) 7
21. A copper ball of density 8.0 g/cc and 1 cm in diameter is immersed in oil of density 0.8 g/cc. The charge on the ball if it remains just suspended in oil in an electric field of intensity 600π V/m acting in the upward direction is _____.

Fill in the blank with the correct answer from the options given below. (Take $g = 10 \text{ m/s}^2$)

- (1) $2 \times 10^{-6} \text{ C}$ (2) $2 \times 10^{-5} \text{ C}$ (3) $1 \times 10^{-5} \text{ C}$ (4) $1 \times 10^{-6} \text{ C}$
22. A metal wire is subjected to a constant potential difference. When the temperature of the metal wire increases, the drift velocity of the electron in it _____.

Fill in the blank with the correct answer from the options given below.

- (1) increases, thermal velocity of the electrons decreases
 (2) decreases, thermal velocity of the electrons decreases
 (3) increases, thermal velocity of the electrons increases
 (4) decreases, thermal velocity of the electrons increases
23. For the given mixed combination of resistors calculate the total resistance between points A and B.

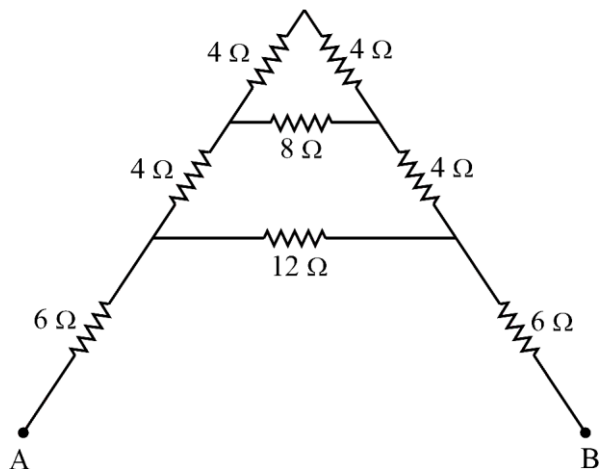

Choose the correct answer from the options given below.

- (1) 9 Ω (2) 18 Ω (3) 4 Ω (4) 14 Ω

SPACE FOR ROUGH WORK

24. A cell of emf 1.1 V and internal resistance 0.5Ω is connected to a wire of resistance 0.5Ω . Another cell of the same emf is now connected in series with the intention of increasing the current but the current in the wire remains the same. The internal resistance of the second cell is _____.

Fill in the blank with the correct answer from the options given below.

- (1) 1Ω (2) 2.5Ω (3) 1.5Ω (4) 2Ω

25. P, Q, R and S are four wires of resistances 3, 3, 3 and 4Ω respectively. They are connected to form the four arms of a wheatstone bridge circuit. The resistance with which S must be shunted in order that the bridge may be balanced is _____.

Fill in the blank with the correct answer from the options given below.

- (1) 14Ω (2) 12Ω (3) 15Ω (4) 7Ω

26. Magnetic moment of a thin bar magnet is 'M'. If it is bent into a semicircular form, its new magnetic moment will be _____.

Fill in the blank with the correct answer from the options given below.

- (1) M/π (2) $M/2$ (3) M (4) $2M/\pi$

27. Ferromagnetic material used in Transformers must have _____.

Fill in the blank with the correct answer from the options given below.

- (1) Low permeability and High Hysteresis loss
(2) High permeability and Low Hysteresis loss
(3) High permeability and High Hysteresis loss
(4) Low permeability and Low Hysteresis loss

28. A conducting ring of radius r is placed in a varying magnetic field perpendicular to the plane of the ring. If the rate at which the magnetic field varies is x , the electric field intensity at any point of the ring is _____.

Fill in the blank with the correct answer from the options given below.

- (1) rx (2) $rx/2$ (3) $2rx$ (4) $4r/x$

29. A 50 Hz ac current of crest value 1 A flows through the primary of a transformer. If the mutual inductance between the primary and secondary be 0.5 H, the crest voltage induced in the secondary is _____.

Fill in the blank with the correct answer from the options given below.

- (1) 75 V (2) 150 V (3) 100 V (4) 200 V

30. A long solenoid of diameter 0.1 m has 2×10^4 turns per meter. At the centre of the solenoid a coil of 100 turns and radius 0.01 m is placed with its axis coinciding with the solenoid axis. The current in the solenoid reduces at a constant rate to 0 A from 4 A in 0.05 s. If the resistance of the coil is $10\pi^2 \Omega$, then the total charge flowing through the coil during this time is _____.

Fill in the blank with the correct answer from the options given below.

- (1) $16 \mu\text{C}$ (2) $32 \mu\text{C}$ (3) $16\pi \mu\text{C}$ (4) $32\pi \mu\text{C}$

SPACE FOR ROUGH WORK

31. Lower half of a convex lens is made opaque. Which of the following statement describes the image of the object placed in front of the lens ?

- (A) No change in image
- (B) Image will show only half of the object
- (C) Intensity of image gets reduced

Choose the correct answer from the options given below.

- (1) (A) only (2) (B) only (3) (C) only (4) (B) and (C) only

32. Two slits are made 0.1 mm apart and the screen is placed 2 m away. The fringe separation when a light of wavelength 500 nm is used is _____.

Fill in the blank with the correct answer from the options given below.

- (1) 1 cm (2) 0.15 cm (3) 1.5 cm (4) 0.1 cm

33. For an astronomical telescope having objective lens of focal length 10 m and eyepiece lens of focal length 10 cm, telescope's the tube length and magnification respectively are _____.

Fill in the blank with the correct answer from the options given below.

- (1) 20 cm, 1 (2) 1000 cm, 1 (3) 1010 cm, 1 (4) 1010 cm, 100

34. According to Bohr's Model

- (A) The radius of the orbiting electron is directly proportional to 'n'.
- (B) The speed of the orbiting electron is directly proportional to '1/n'.
- (C) The magnitude of the total energy of the orbiting electron is directly proportional to '1/n²'.
- (D) The radius of the orbiting electron is directly proportional to 'n²'.

Choose the correct answer from the options given below.

- (1) (A), (B) and (C) only (2) (A), (B) and (D) only
(3) (A), (B), (C) and (D) (4) (B), (C) and (D) only

35. For a full wave rectifier, if the input frequency is 50 Hz, the output frequency will be _____.

Fill in the blank with the correct answer from the options given below.

- (1) 50 Hz (2) 100 Hz (3) 25 Hz (4) 0 Hz

36. For an electric dipole in a non-uniform electric field with dipole moment parallel to direction of the field, the force F and torque τ on the dipole respectively are _____.

Fill in the blank with the correct answer from the options given below.

- (1) $F = 0, \tau = 0$ (2) $F \neq 0, \tau = 0$ (3) $F = 0, \tau \neq 0$ (4) $F \neq 0, \tau \neq 0$

SPACE FOR ROUGH WORK

37. Two large plane parallel sheets shown in the figure have equal but opposite surface charge densities $+\sigma$ and $-\sigma$. A point charge q placed at points P_1 , P_2 and P_3 experiences forces F_1 , F_2 and F_3 respectively. Then

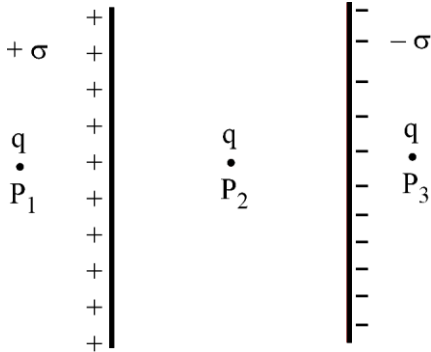

Choose the correct answer from the options given below.

- (1) $\vec{F}_1 = 0, \vec{F}_2 = 0, \vec{F}_3 = 0$ (2) $\vec{F}_1 = 0, \vec{F}_2 \neq 0, \vec{F}_3 = 0$
 (3) $\vec{F}_1 \neq 0, \vec{F}_2 \neq 0, \vec{F}_3 \neq 0$ (4) $\vec{F}_1 = 0, \vec{F}_3 \neq 0, \vec{F}_2 = 0$
38. Two charged metallic spheres with radii R_1 and R_2 are brought in contact and then separated. The ratio of final charges Q_1 and Q_2 on the two spheres respectively will be _____.

Fill in the blank with the correct answer from the options given below.

- (1) $\frac{Q_1}{Q_2} = \frac{R_2}{R_1}$ (2) $\frac{Q_1}{Q_2} < \frac{R_1}{R_2}$ (3) $\frac{Q_1}{Q_2} > \frac{R_1}{R_2}$ (4) $\frac{Q_1}{Q_2} = \frac{R_1}{R_2}$
39. Two charged particles, placed at a distance d apart in vacuum, exert a force F on each other. Now, each of the charges is doubled. To keep the force unchanged, the distance between the charges should be changed to _____.

Fill in the blank with the correct answer from the options given below.

- (1) $4d$ (2) $2d$ (3) d (4) $d/2$
40. Two parallel plate capacitors of capacitances $2 \mu\text{F}$ and $3 \mu\text{F}$ are joined in series and the combination is connected to a battery of V volts. The values of potential across the two capacitors V_1 and V_2 and energy stored in the two capacitors U_1 and U_2 respectively are related as _____.

Fill in the blank with the correct answer from the options given below.

- (1) $\frac{V_1}{V_2} = \frac{U_1}{U_2} = \frac{3}{2}$ (2) $\frac{V_1}{V_2} = \frac{U_1}{U_2} = \frac{2}{3}$
 (3) $\frac{V_1}{V_2} = \frac{3}{2}$ and $\frac{U_1}{U_2} = \frac{2}{3}$ (4) $\frac{V_1}{V_2} = \frac{2}{3}$ and $\frac{U_1}{U_2} = \frac{3}{2}$

SPACE FOR ROUGH WORK

41. Two resistances of $100\ \Omega$ and $200\ \Omega$ are connected in series across a $20\ \text{V}$ battery as shown in figure below. The reading in a $200\ \Omega$ voltmeter connected across the $200\ \Omega$ resistance is _____.

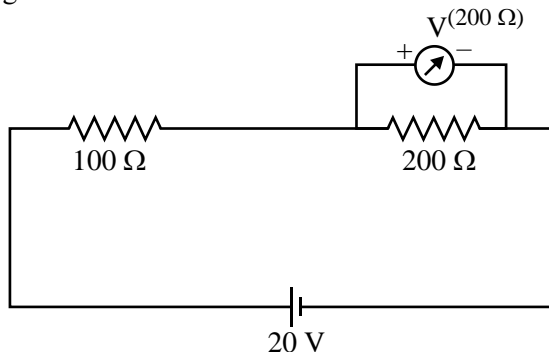

Fill in the blank with the correct answer from the options given below.

- (1) $4\ \text{V}$ (2) $\frac{20}{3}\ \text{V}$ (3) $10\ \text{V}$ (4) $16\ \text{V}$
42. The current through a $\frac{4}{3}\ \Omega$ external resistance connected to a parallel combination of two cells of $2\ \text{V}$ and $1\ \text{V}$ emf and internal resistances of $1\ \Omega$ and $2\ \Omega$ respectively is _____.
Fill in the blank with the correct answer from the options given below.
- (1) $1\ \text{A}$ (2) $\frac{2}{3}\ \text{A}$ (3) $\frac{3}{4}\ \text{A}$ (4) $\frac{5}{6}\ \text{A}$
43. A metallic wire of uniform area of cross section has a resistance R , resistivity ρ and power rating P at V volts. The wire is uniformly stretched to reduce the radius to half the original radius. The values of resistance, resistivity and power rating at V volts are now denoted by R' , ρ' and P' respectively. The corresponding values are correctly related as _____.
Fill in the blank with the correct answer from the options given below.
- (1) $\rho' = 2\rho, R' = 2R, P' = 2P$ (2) $\rho' = (1/2)\rho, R' = (1/2)R, P' = (1/2)P$
(3) $\rho' = \rho, R' = 16R, P' = (1/16)P$ (4) $\rho' = \rho, R' = (1/16)R, P' = 16P$
44. Three magnetic materials are listed below
(A) paramagnetics (B) diamagnetics (C) ferromagnetics
Choose the correct order of the materials in increasing order of magnetic susceptibility.
- (1) (A), (B), (C) (2) (C), (A), (B) (3) (B), (A), (C) (4) (B), (C), (A)
45. Two infinitely long straight parallel conductors carrying currents I_1 and I_2 are held at a distance d apart in vacuum. The force F on a length L of one of the conductors due to the other is _____.
Fill in the blank with the correct answer from the options given below.
- (1) proportional to L but independent of $I_1 \times I_2$ (2) proportional to $I_1 \times I_2$ but independent of length L
(3) proportional to $I_1 \times I_2 \times L$ (4) proportional to $\frac{L}{I_1 \times I_2}$

SPACE FOR ROUGH WORK

46. In the circuit shown below, a current $3I$ enters at A. The semicircular parts ABC and ADC have equal radii 'r' but resistances $2R$ and R respectively. The magnetic field at the center of the circular loop ABCD is _____.

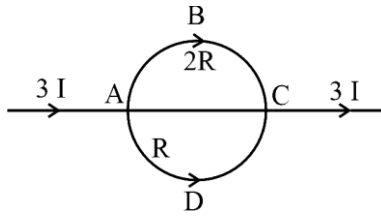

Fill in the blank with the correct answer from the options given below.

- (1) $\frac{\mu_0 I}{4r}$ out of the plane (2) $\frac{\mu_0 I}{4r}$ into the plane
 (3) $\frac{\mu_0 3I}{4r}$ out of the plane (4) $\frac{\mu_0 3I}{4r}$ into the plane
47. A square loop with each side 1 cm, carrying a current of 10 A, is placed in a magnetic field of 0.2 T. The direction of magnetic field is parallel to the plane of the loop. The torque experienced by the loop is _____. Fill in the blank with the correct answer from the options given below.
 (1) zero (2) 2×10^{-4} Nm (3) 2×10^{-2} Nm (4) 2 Nm
48. In an ac circuit, the current leads the voltage by $\pi/2$. The circuit is _____. Fill in the blank with the correct answer from the options given below.
 (1) purely resistive (2) should have circuit elements with resistance equal to reactance.
 (3) purely inductive (4) purely capacitive
49. In a pair of adjacent coils, for a change of current in one of the coils from 0 A to 10 A in 0.25 s, the magnetic flux in the adjacent coil changes by 15 Wb. The mutual inductance of the coils is _____. Fill in the blank with the correct answer from the options given below.
 (1) 120 H (2) 12 H (3) 1.5 H (4) 0.75 H
50. A wire of irregular shape in figure (a) and a circular loop of wire in figure (b) are placed in different uniform magnetic fields as shown in the figures below. In figure (a), the magnetic field is perpendicular into the plane. In figure (b), the magnetic field is perpendicular out of the plane.

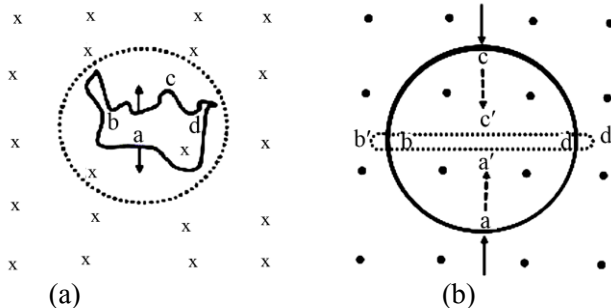

The wire in figure (a) is turning into a circular loop and that in figure (b) into a narrow straight wire. The direction of induced current will be _____.

Fill in the blank with the correct answer from the options given below.

- (1) clockwise in both (a) and (b) (2) anticlockwise in both (a) and (b)
 (3) clockwise in (a) and anticlockwise in (b) (4) anticlockwise in (a) and clockwise in (b)

SPACE FOR ROUGH WORK

SPACE FOR ROUGH WORK

SPACE FOR ROUGH WORK

Read carefully the following instructions :

8. No candidate will be allowed to leave the OMR Answer Sheet blank. If any OMR Answer Sheet is found blank, it shall be crossed by the Invigilator with his/her signature, mentioning "Cancelled" on it.
9. Do not tear or fold any page of the Test Booklet and OMR Answer Sheet.
10. Candidates are advised to ensure that they fill the correct particulars on the OMR Answer Sheet, i.e., Application No., Roll No., Test Booklet No., Name, Mother's Name, Father's Name and Signature.
11. Rough work is to be done in the space provided for this purpose in the Test Booklet only.
12. The answers will be evaluated through electronic scanning process. Incomplete or incorrect entries may render the OMR Answer Sheet invalid.
13. Candidates are advised not to fold or make any stray marks on the OMR Answer Sheet. Use of Eraser, Nail, Blade, White Fluid/Whitener, etc., to smudge, scratch or damage in any manner the OMR Answer Sheet during examination is strictly prohibited. Candidature and OMR Answer Sheet of candidates using Eraser, Nail, Blade or White Fluid/Whitener to smudge, scratch or damage in any manner shall be cancelled.
14. There will be one copy of OMR Answer Sheet i.e., the Original Copy. After the examination is over, the candidate shall hand over the OMR Answer Sheet to the Invigilator. The candidate can take away the Test Booklet after the examination is over. If the candidate does not hand over the OMR Answer Sheet to the Invigilator and goes away with the OMR Answer Sheet, his/her candidature shall be cancelled and criminal proceedings shall also be initiated against him/her.
15. Candidates are advised strictly not to carry handkerchief, any mobile phone, any type of watch, belt or wear ornaments like ring, chain, ear-ring, etc., electronic or communication device, pen, pencil, eraser, sharpener and correction fluid to the Examination Centre. If any candidate is found possessing any such item, he/she will not be allowed to enter the examination centre. Possession of a mobile phone or any other aiding material as mentioned above by the candidate in the examination room will be treated as a serious violation and it may lead to cancellation of the candidature and debarring him/her from future examinations.
16. If a candidate violates any instructions or shows any indiscipline or misbehaviour, appropriate action will be taken including cancellation of candidature and debarring from future examinations.
17. Use of electronic/manual calculator is **not** allowed.