

## CUET UG Physics Question Paper 2024 Set A with solution

1. Two charged particles, placed at a distance  $d$  apart in vacuum, exert a force  $F$  on each other. Now, each of the charges is doubled. To keep the force unchanged, the distance between the charges should be changed to \_\_\_\_\_.

Fill in the blank with the correct answer from the options given below.

- (1)  $4d$
- (2)  $2d$
- (3)  $d$
- (4)  $\frac{d}{2}$

**Correct Answer: (2)  $2d$ .**

**Solution:** According to Coulomb's law, the force between two charges is given by  $F = k \frac{q_1 q_2}{d^2}$ . When each charge is doubled, to keep the force constant, the distance  $d$  must be increased by a factor of  $\sqrt{4} = 2$ , so the new distance is  $2d$ .

### Quick Tip

To keep the force constant when charges are doubled, the distance between them should be increased by a factor of 2.

2. Two parallel plate capacitors of capacitances  $2 \mu\text{F}$  and  $3 \mu\text{F}$  are joined in series and the combination is connected to a battery of  $V$  volts. The values of potential across the two capacitors  $V_1$  and  $V_2$  and energy stored in the two capacitors  $U_1$  and  $U_2$  respectively are related as \_\_\_\_\_.

Fill in the blank with the correct answer from the options given below.

- (1)  $\frac{V_2}{V_1} = \frac{U_2}{U_1} = \frac{2}{3}$
- (2)  $\frac{V_2}{V_1} = \frac{U_2}{U_1} = \frac{3}{2}$
- (3)  $\frac{V_2}{V_1} = \frac{2}{3}$  and  $\frac{U_2}{U_1} = \frac{3}{2}$
- (4)  $\frac{V_2}{V_1} = \frac{3}{2}$  and  $\frac{U_2}{U_1} = \frac{2}{3}$

**Correct Answer:** (4)  $\frac{V_2}{V_1} = \frac{3}{2}$  and  $\frac{U_2}{U_1} = \frac{2}{3}$ .

**Solution:** In series, the potential across each capacitor is inversely proportional to the capacitance. Since  $C_1 = 2 \mu F$  and  $C_2 = 3 \mu F$ , the ratio  $\frac{V_2}{V_1} = \frac{C_1}{C_2} = \frac{3}{2}$ . The energy stored in a capacitor is proportional to  $C \times V^2$ , so the energy ratio is  $\frac{U_2}{U_1} = \frac{2}{3}$ .

#### Quick Tip

For capacitors in series, the potential across each capacitor is inversely proportional to the capacitance, and the energy stored is proportional to  $C \times V^2$ .

**3. Two large plane parallel sheets shown in the figure have equal but opposite surface charge densities  $+\sigma$  and  $-\sigma$ . A point charge  $q$  placed at points  $P_1$ ,  $P_2$ , and  $P_3$  experiences forces  $\vec{F}_1$ ,  $\vec{F}_2$ , and  $\vec{F}_3$  respectively. Then,**

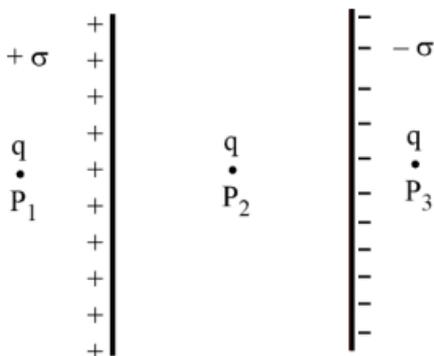

Choose the correct answer from the options given below.

- (1)  $\vec{F}_1 = 0, \vec{F}_2 = 0, \vec{F}_3 = 0$
- (2)  $\vec{F}_1 = 0, \vec{F}_2 \neq 0, \vec{F}_3 = 0$
- (3)  $\vec{F}_1 \neq 0, \vec{F}_2 \neq 0, \vec{F}_3 \neq 0$
- (4)  $\vec{F}_1 = 0, \vec{F}_3 \neq 0, \vec{F}_2 = 0$

**Correct Answer:** (2)  $\vec{F}_1 = 0, \vec{F}_2 \neq 0, \vec{F}_3 = 0$ .

**Solution:** The point charge placed at  $P_1$  and  $P_3$ , which are on the outer sides of the sheets, experiences no net force because the fields outside the sheets cancel out. However, the point charge at  $P_2$  between the sheets experiences a net force due to the field between the oppositely charged sheets.

### Quick Tip

When two parallel plates have equal and opposite charge densities, the electric field inside the plates is uniform, but outside the plates, the field cancels out.

**4. Two charged metallic spheres with radii  $R_1$  and  $R_2$  are brought in contact and then separated. The ratio of final charges  $Q_1$  and  $Q_2$  on the two spheres respectively will be**

-----.

Fill in the blank with the correct answer from the options given below.

(1)  $\frac{Q_2}{Q_1} = \frac{R_1}{R_2}$

(2)  $\frac{Q_2}{Q_1} < \frac{R_1}{R_2}$

(3)  $\frac{Q_2}{Q_1} > \frac{R_1}{R_2}$

(4)  $\frac{Q_2}{Q_1} = \frac{R_2}{R_1}$

**Correct Answer:** (4)  $\frac{Q_2}{Q_1} = \frac{R_2}{R_1}$ .

**Solution:** When two metallic spheres are brought into contact, charge distribution occurs in such a way that the charge density on both spheres becomes equal. The ratio of final charges is proportional to the ratio of their radii, i.e.,  $\frac{Q_2}{Q_1} = \frac{R_2}{R_1}$ .

### Quick Tip

When metallic spheres are brought into contact, the charge distribution results in a ratio of charges proportional to the radii of the spheres.

**5. Two resistances of  $100 \Omega$  and  $200 \Omega$  are connected in series across a  $20 \text{ V}$  battery as shown in the figure below. The reading in a  $200 \Omega$  voltmeter connected across the  $200 \Omega$  resistance is** -----.

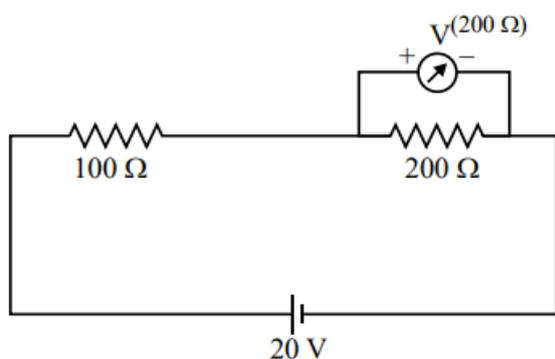

Fill in the blank with the correct answer from the options given below.

- (1) 4 V
- (2)  $\frac{20}{3}$  V
- (3) 10 V
- (4) 16 V

**Correct Answer:** (2)  $\frac{20}{3}$  V.

**Solution:** The resistances are in series, so the total resistance is  $R_{\text{total}} = 100 \Omega + 200 \Omega = 300 \Omega$ .

The current in the circuit is  $I = \frac{20}{300} = \frac{1}{15}$  A.

The voltage across the 200  $\Omega$  resistance is  $V = IR = \frac{1}{15} \times 200 = \frac{200}{15} = \frac{20}{3}$  V.

#### Quick Tip

When resistors are connected in series, the total resistance is the sum of the individual resistances, and the same current flows through both resistors.

**6. The current through a  $\frac{4}{3} \Omega$  external resistance connected to a parallel combination of two cells of 2 V and 1 V emf and internal resistances of 1  $\Omega$  and 2  $\Omega$  respectively is**

-----.

Fill in the blank with the correct answer from the options given below.

- (1) 1 A
- (2)  $\frac{2}{3}$  A
- (3)  $\frac{3}{4}$  A

(4)  $\frac{5}{6}$  A

**Correct Answer:** (4)  $\frac{5}{6}$  A.

**Solution:** The total emf of the combination of cells in parallel is given by  $\frac{E_{\text{total}}}{R_{\text{total}}} = \frac{E_1}{r_1} + \frac{E_2}{r_2}$ .  
Substituting the given values, we find the total emf and internal resistance. Then, the current is calculated using Ohm's law  $I = \frac{E_{\text{total}}}{R_{\text{total}} + R_{\text{external}}}$ .

Quick Tip

When cells are connected in parallel, the total emf and internal resistance are calculated using reciprocal sums.

**7. A metallic wire of uniform area of cross-section has a resistance  $R$ , resistivity  $\rho$ , and power rating  $P$  at  $V$  volts. The wire is uniformly stretched to reduce the radius to half the original radius. The values of resistance, resistivity, and power rating at  $V$  volts are now denoted by  $R'$ ,  $\rho'$ , and  $P'$  respectively. The corresponding values are correctly related as -----.**

Fill in the blank with the correct answer from the options given below.

(1)  $\rho' = 2\rho, R' = 2R, P' = 2P$

(2)  $\rho' = \frac{1}{2}\rho, R' = \frac{1}{2}R, P' = \frac{1}{2}P$

(3)  $\rho' = \rho, R' = 16R, P' = \frac{1}{16}P$

(4)  $\rho' = \rho, R' = \frac{1}{16}R, P' = 16P$

**Correct Answer:** (3)  $\rho' = \rho, R' = 16R, P' = \frac{1}{16}P$ .

**Solution:** When the wire is stretched uniformly, the length increases, and the area decreases. The new resistance is proportional to the square of the change in length, which in this case leads to a 16-fold increase in resistance and a corresponding decrease in power.

### Quick Tip

Stretching a wire increases its resistance by the square of the ratio of the new length to the original length, while resistivity remains unchanged.

### 8. Three magnetic materials are listed below:

- (A) Paramagnetics
- (B) Diamagnetics
- (C) Ferromagnetics

Choose the correct order of the materials in increasing order of magnetic susceptibility.

- (1) (A), (B), (C)
- (2) (C), (A), (B)
- (3) (B), (A), (C)
- (4) (B), (C), (A)

**Correct Answer:** (3) (B), (A), (C).

**Solution:** Diamagnetic materials have the lowest magnetic susceptibility, followed by paramagnetic materials, and ferromagnetic materials have the highest susceptibility.

### Quick Tip

Magnetic susceptibility increases from diamagnetic to paramagnetic to ferromagnetic materials.

### 9. Two infinitely long straight parallel conductors carrying currents $I_1$ and $I_2$ are held at a distance $d$ apart in vacuum. The force $F$ on a length $L$ of one of the conductors due to the other is .....

Fill in the blank with the correct answer from the options given below.

- (1) proportional to  $L$  but independent of  $I_1 \times I_2$
- (2) proportional to  $I_1 \times I_2$  but independent of length  $L$
- (3) proportional to  $I_1 \times I_2 \times L$
- (4) proportional to  $\frac{L}{I_1 \times I_2}$

**Correct Answer:** (3) proportional to  $I_1 \times I_2 \times L$ .

**Solution:** The force between two parallel current-carrying conductors is given by  $F = \frac{\mu_0 I_1 I_2 L}{2\pi d}$ , meaning the force is proportional to the product of the currents  $I_1$  and  $I_2$ , the length of the conductor  $L$ , and inversely proportional to the distance  $d$  between them.

**Quick Tip**

The force between two parallel current-carrying conductors depends on the product of the currents, the length of the conductors, and the distance between them.

**10. In the circuit shown below, a current  $3I$  enters at A. The semicircular parts ABC and ADC have equal radii  $r$  but resistances  $2R$  and  $R$  respectively. The magnetic field at the center of the circular loop ABCD is .....**

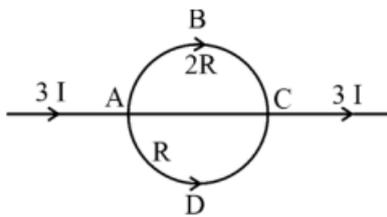

Fill in the blank with the correct answer from the options given below.

- (1)  $\frac{\mu_0 I}{4r}$  out of the plane
- (2)  $\frac{\mu_0 I}{4r}$  into the plane
- (3)  $\frac{\mu_0 3I}{4r}$  out of the plane
- (4)  $\frac{\mu_0 3I}{4r}$  into the plane

**Correct Answer:** (4)  $\frac{\mu_0 3I}{4r}$  into the plane.

**Solution:** The magnetic field at the center of a loop carrying current is given by  $B = \frac{\mu_0 I}{2r}$ . The combination of two semicircular currents leads to a net magnetic field proportional to the sum of the currents and inversely proportional to the radius.

### Quick Tip

The direction of the magnetic field is determined by the right-hand rule, with the net magnetic field pointing into the plane of the loop.

**11. A square loop with each side 1 cm, carrying a current of 10 A, is placed in a magnetic field of 0.2 T. The direction of the magnetic field is parallel to the plane of the loop. The torque experienced by the loop is -----.**

Fill in the blank with the correct answer from the options given below.

- (1) zero
- (2)  $2 \times 10^{-4}$  Nm
- (3)  $2 \times 10^{-2}$  Nm
- (4) 2 Nm

**Correct Answer: (1) zero.**

**Solution:** When the magnetic field is parallel to the plane of the loop, no net torque is experienced by the loop. Torque depends on the angle between the magnetic field and the area vector of the loop.

### Quick Tip

If the magnetic field is parallel to the plane of a current-carrying loop, the torque on the loop is zero.

**12. In an AC circuit, the current leads the voltage by  $\pi/2$ . The circuit is -----.**

Fill in the blank with the correct answer from the options given below.

- (1) purely resistive
- (2) should have circuit elements with resistance equal to reactance.
- (3) purely inductive
- (4) purely capacitive

**Correct Answer: (4) purely capacitive.**

**Solution:** In a purely capacitive AC circuit, the current leads the voltage by  $90^\circ$  (or  $\pi/2$  radians), indicating that the circuit is capacitive.

### Quick Tip

In a purely capacitive circuit, the current leads the voltage by  $90^\circ$ .

**13. In a pair of adjacent coils, for a change of current in one of the coils from 0 A to 10 A in 0.25 s, the magnetic flux in the adjacent coil changes by 15 Wb. The mutual inductance of the coils is .....**

Fill in the blank with the correct answer from the options given below.

- (1) 120 H
- (2) 12 H
- (3) 1.5 H
- (4) 0.75 H

**Correct Answer: (3) 1.5 H.**

**Solution:** The mutual inductance  $M$  is given by  $M = \frac{\Delta\Phi}{\Delta I}$ . Substituting the values,  $M = \frac{15}{10} = 1.5$  H.

### Quick Tip

Mutual inductance is the ratio of the change in magnetic flux to the change in current in a pair of coupled coils.

**14. A wire of irregular shape in figure (a) and a circular loop of wire in figure (b) are placed in different uniform magnetic fields as shown in the figures below. In figure (a), the magnetic field is perpendicular into the plane. In figure (b), the magnetic field is perpendicular out of the plane.**

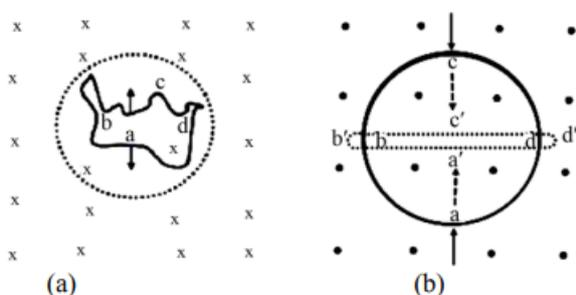

The wire in figure (a) is turning into a circular loop and that in figure (b) into a narrow straight wire. The direction of induced current will be .....

Fill in the blank with the correct answer from the options given below.

- (1) clockwise in both (a) and (b)
- (2) anticlockwise in both (a) and (b)
- (3) clockwise in (a) and anticlockwise in (b)
- (4) anticlockwise in (a) and clockwise in (b)

**Correct Answer:** (3) clockwise in (a) and anticlockwise in (b).

**Solution:** According to Lenz's law, the induced current will oppose the change in magnetic flux. In figure (a), as the wire turns into a circular loop, the area of the loop increases, increasing the magnetic flux into the plane. To oppose this increase, the induced current will be clockwise. In figure (b), the wire is turning into a straight line, decreasing the area and the magnetic flux out of the plane, so the induced current will be anticlockwise to oppose this change.

Quick Tip

Lenz's law states that the direction of induced current will always oppose the change in magnetic flux.

---

**15. Match List-I has four graphs showing variation of opposition to flow of ac versus frequency with circuit characteristic in List-II.**

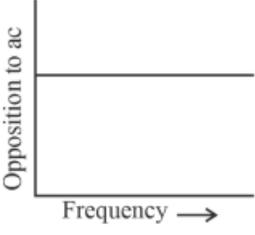
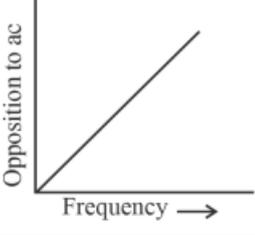
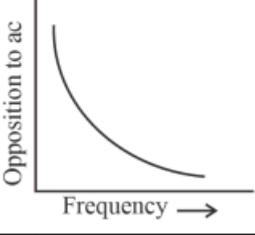
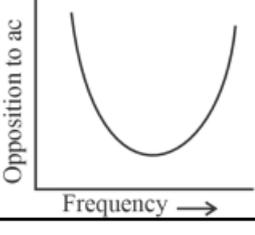
List-I		List-II	
(A)		(I)	Impedance
(B)		(II)	Capacitive reactance
(C)		(III)	Inductive reactance
(D)		(IV)	Resistance

Choose the correct answer from the options given below.

- (1) (A) - (I), (B) - (II), (C) - (III), (D) - (IV)
- (2) (A) - (IV), (B) - (III), (C) - (II), (D) - (I)
- (3) (A) - (I), (B) - (II), (C) - (IV), (D) - (III)
- (4) (A) - (III), (B) - (IV), (C) - (I), (D) - (II)

**Correct Answer:** (4) (A) - (III), (B) - (IV), (C) - (I), (D) - (II).

**Solution:** Each graph in List-I corresponds to a characteristic of an AC circuit in List-II, showing how the opposition to the flow of AC changes with frequency. This match is based on the behavior of impedance, reactance, and resonance.

#### Quick Tip

Remember that resonance occurs when inductive and capacitive reactances cancel out, and the opposition to AC is determined by the reactance and resistance in the circuit.

---

**16. In an electromagnetic wave, the ratio of energy densities of electric and magnetic fields is .....**

Fill in the blank with the correct answer from the options given below.

- (1) 1 : 1
- (2) 1 : c
- (3) c : 1
- (4) 1 : c<sup>2</sup>

**Correct Answer: (1) 1 : 1.**

**Solution:** In an electromagnetic wave, the energy density of the electric field is equal to the energy density of the magnetic field. Therefore, the ratio of their energy densities is 1:1.

**Quick Tip**

In electromagnetic waves, the energy is equally divided between the electric and magnetic fields, and their energy densities are in a 1:1 ratio.

---

**17. Of the following, the correct arrangement of electromagnetic spectrum in decreasing order of wavelength is .....**

Fill in the blank with the correct answer from the options given below.

- 1. Radio waves, X-rays, Infrared waves, microwaves, visible waves
- 2. Infrared waves, microwaves, Radio waves, X-rays, visible waves
- 3. Radio waves, microwaves, Infrared waves, visible waves, X-rays
- 4. X-rays, visible waves, Infrared waves, microwaves, Radio waves

**Correct Answer: (3) Radio waves, microwaves, Infrared waves, visible waves, X-rays.**

**Solution:** The correct arrangement of the electromagnetic spectrum in decreasing order of wavelength is: Radio waves (longest wavelength), microwaves, infrared, visible light, and X-rays (shortest wavelength).

### Quick Tip

Remember: As wavelength decreases, the energy of the electromagnetic wave increases. X-rays have shorter wavelengths and higher energy compared to visible light and microwaves.

### 18. Match Electromagnetic waves listed in Column I with Production method/device in Column II.

Column-I: Electromagnetic waves	Column-II: Production method/device
(A) Microwaves	(I) LC oscillator
(B) Infrared	(II) Magnetron
(C) X-rays	(III) Vibration of atoms/molecules
(D) Radio waves	(IV) Bombarding large atomic number metal target with fast-moving electrons

The correctly matched combination is as in option:

1. (A) - (I), (B) - (II), (C) - (III), (D) - (IV)
2. (A) - (II), (B) - (III), (C) - (IV), (D) - (I)
3. (A) - (II), (B) - (I), (C) - (IV), (D) - (III)
4. (A) - (III), (B) - (IV), (C) - (I), (D) - (II)

**Correct Answer:** (2) (A) - (II), (B) - (III), (C) - (IV), (D) - (I).

**Solution:** - (A) Microwaves are produced by a magnetron, making (II) correct. - (B) Infrared waves are produced by the vibration of atoms/molecules, making (III) correct. - (C) X-rays are produced by bombarding a large atomic number metal target with fast-moving electrons, making (IV) correct. - (D) Radio waves are produced by an LC oscillator, making (I) correct.

### Quick Tip

Different electromagnetic waves have distinct production mechanisms: microwaves by a magnetron, X-rays by bombarding heavy metal targets, and radio waves by oscillators.

### 19. In the figure given below, APB is a curved surface of radius of curvature 10 cm sep-

refracting air and a transparent material ( $\mu = \frac{4}{3}$ ). A point object O is placed in air on the principal axis of the surface 20 cm from P. The distance of the image of O from P will be .....

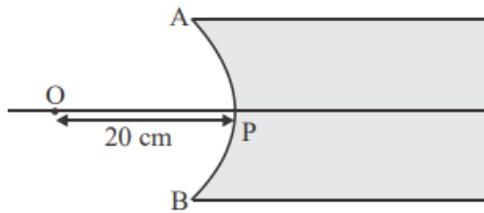

Fill in the blank with the correct answer from the options given below.

1. 16 cm left of P in air
2. 16 cm right of P in water
3. 20 cm right of P in water
4. 20 cm left of P in air

**Correct Answer: (1) 16 cm left of P in air.**

**Solution:** The refraction at a spherical surface is governed by the formula:

$$\frac{\mu_2}{v} - \frac{\mu_1}{u} = \frac{\mu_2 - \mu_1}{R}$$

where:

$$\mu_1 = 1 \text{ (for air), } \mu_2 = \frac{4}{3}, \quad u = -20 \text{ cm, } R = 10 \text{ cm}$$

Substitute the values into the formula:

$$\frac{\frac{4}{3}}{v} - \frac{1}{-20} = \frac{\frac{4}{3} - 1}{10}$$

Simplifying:

$$\begin{aligned} \frac{\frac{4}{3}}{v} + \frac{1}{20} &= \frac{1}{30} \\ \frac{4}{3v} &= \frac{1}{30} - \frac{1}{20} = \frac{2-3}{60} = \frac{-1}{60} \end{aligned}$$

Thus,  $v = -16$  cm. This means the image is 16 cm to the left of P in air.

### Quick Tip

To solve refraction problems at curved surfaces, use the formula for spherical refraction, and remember that a negative value of  $v$  indicates that the image is on the same side as the object.

**20. For fixed values of radii of curvature of lens, power of the lens will be .....**

Fill in the blank with the correct answer from the options given below.

1.  $P \propto (\mu - 1)$
2.  $P \propto \mu^2$
3.  $P \propto \frac{1}{\mu}$
4.  $P \propto \mu^{-2}$

**Correct Answer:** (1)  $P \propto (\mu - 1)$ .

**Solution:** The power  $P$  of a lens is related to the refractive index  $\mu$  and the radii of curvature  $R_1$  and  $R_2$  by the Lensmaker's formula:

$$P = (\mu - 1) \left( \frac{1}{R_1} - \frac{1}{R_2} \right)$$

For fixed values of the radii of curvature  $R_1$  and  $R_2$ , the power of the lens is directly proportional to  $\mu - 1$ . Therefore,  $P \propto (\mu - 1)$ .

### Quick Tip

In lens formulas, the power depends on the refractive index  $\mu$  and the shape of the lens. For a given shape (fixed radii of curvature), the refractive index primarily determines the lens's power.

**21. The graph correctly representing the variation of image distance 'v' for a convex lens of focal length 'f' versus object distance 'u' is .....**

Fill in the blank with the correct answer from the options given below.

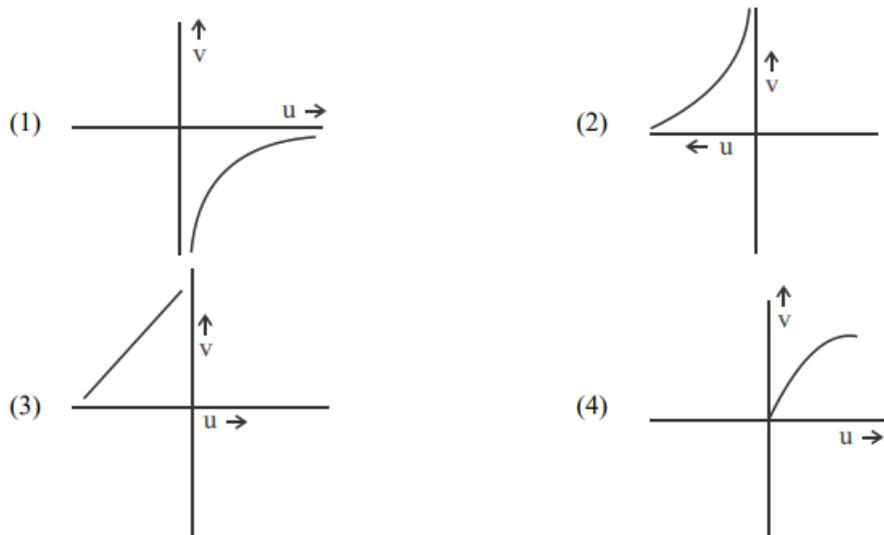

**Correct Answer:** (3) A curve that approaches but never reaches the focal length on either axis.

**Solution:** For a convex lens, the relationship between object distance  $u$ , image distance  $v$ , and the focal length  $f$  is given by the lens formula:

$$\frac{1}{f} = \frac{1}{v} + \frac{1}{u}$$

This equation indicates that as the object distance approaches infinity, the image distance approaches the focal length from the positive side. Similarly, as the object moves closer to the lens, the image distance changes rapidly. Therefore, the graph is a curve that approaches the focal length but never touches it.

#### Quick Tip

For a convex lens, the image distance  $v$  increases as the object distance  $u$  decreases, and the relationship follows a hyperbolic-like curve. The focal point  $f$  is the limit.

**22. Using light from a monochromatic source to study diffraction in a single slit of width 0.1 mm, the linear width of central maxima is measured to be 5 mm on a screen held 50 cm away. The wavelength of light used is .....**

Fill in the blank with the correct answer from the options given below.

1.  $2.5 \times 10^{-7}$  m

2.  $4 \times 10^{-7}$  m

3.  $5 \times 10^{-7} \text{ m}$

4.  $7.5 \times 10^{-7} \text{ m}$

**Correct Answer:** (3)  $5 \times 10^{-7} \text{ m}$ .

**Solution:** The width of the central maximum in single-slit diffraction is given by:

$$w = \frac{2\lambda D}{a}$$

where:

- $w = 5 \text{ mm} = 5 \times 10^{-3} \text{ m}$  (width of central maximum),
- $D = 50 \text{ cm} = 0.5 \text{ m}$  (distance to the screen),
- $a = 0.1 \text{ mm} = 1 \times 10^{-4} \text{ m}$  (slit width),
- $\lambda$  is the wavelength of light.

Rearranging the formula for  $\lambda$ :

$$\lambda = \frac{wa}{2D} = \frac{5 \times 10^{-3} \times 1 \times 10^{-4}}{2 \times 0.5} = 5 \times 10^{-7} \text{ m}$$

#### Quick Tip

In single-slit diffraction, the width of the central maximum depends on the wavelength, slit width, and distance to the screen. Use  $w = \frac{2\lambda D}{a}$  for calculations.

**23. Radiation of frequency  $2\nu_0$  is incident on a metal with threshold frequency  $\nu_0$ . The correct statement of the following is \_\_\_\_\_.**

Fill in the blank with the correct answer from the options given below.

1. No photoelectrons will be emitted
2. All photoelectrons emitted will have kinetic energy equal to  $h\nu_0$
3. Maximum kinetic energy of photoelectrons emitted can be  $h\nu_0$
4. Maximum kinetic energy of photoelectrons emitted will be  $2h\nu_0$

**Correct Answer:** (3) Maximum kinetic energy of photoelectrons emitted can be  $h\nu_0$ .

**Solution:** According to Einstein's photoelectric equation, the maximum kinetic energy  $K_{\max}$

of the photoelectrons is given by:

$$K_{\max} = h\nu - h\nu_0$$

where  $\nu$  is the frequency of incident radiation and  $\nu_0$  is the threshold frequency. If the radiation has a frequency  $2\nu_0$ , then:

$$K_{\max} = h(2\nu_0) - h\nu_0 = h\nu_0$$

#### Quick Tip

In the photoelectric effect, the maximum kinetic energy of photoelectrons depends on the difference between the frequency of the incident light and the threshold frequency.

**24. A point source causing photoelectric emission from a metallic plate is moved away from the plate. The variation of photoelectric current with distance from the source is correctly represented by the graph -----.**

Fill in the blank with the correct answer from the options given below.

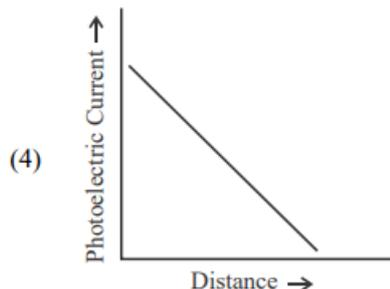
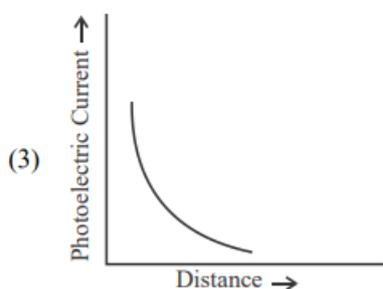
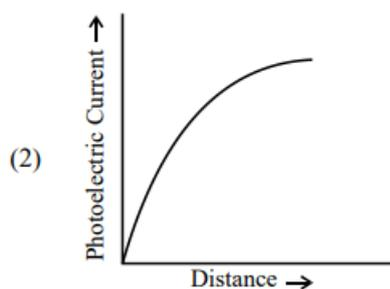
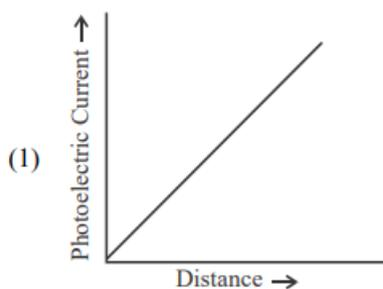

**Correct Answer: (2) A curve that decreases rapidly and then levels off.**

**Solution:** The photoelectric current depends on the intensity of light reaching the metallic surface. As the point source moves farther away from the plate, the intensity of light (and hence the photoelectric current) decreases. Since light intensity follows an inverse square law ( $I \propto \frac{1}{r^2}$ ), the current initially decreases rapidly as the distance increases, but eventually it

levels off at zero when the light is too weak to cause photoemission.

**Quick Tip**

The photoelectric current decreases as the distance from the light source increases, following the inverse square law of intensity. As the light weakens, the emission stops.

**25. A proton accelerated through a potential difference  $V$  has a de Broglie wavelength  $\lambda$ . On doubling the accelerating potential, de Broglie wavelength of the proton .....**

Fill in the blank with the correct answer from the options given below.

1. remains unchanged
2. becomes double
3. becomes four times
4. decreases

**Correct Answer: (4) decreases.**

**Solution:** The de Broglie wavelength  $\lambda$  of a particle is inversely proportional to the square root of its kinetic energy:

$$\lambda \propto \frac{1}{\sqrt{V}}$$

When the accelerating potential is doubled, the kinetic energy of the proton increases, and the wavelength decreases by a factor of  $\sqrt{2}$ . Thus, the wavelength decreases.

**Quick Tip**

For charged particles like protons, the de Broglie wavelength is inversely proportional to the square root of the accelerating potential, so increasing the potential decreases the wavelength.

**26. The kinetic energy of an electron in the ground level of a hydrogen atom is  $K$  units. The values of its potential energy and total energy respectively are .....**

Fill in the blank with the correct answer from the options given below.

1.  $-2K; -K$

2.  $+2K; -K$
3.  $-K; +2K$
4.  $+K; +2K$

**Correct Answer:** (1)  $-2K; -K$ .

**Solution:** In a hydrogen atom, the total energy  $E$  and kinetic energy  $K$  are related by:

$$E_{\text{total}} = -K$$

The potential energy  $U$  is:

$$U = -2K$$

Thus, the total energy is  $-K$ , and the potential energy is  $-2K$ .

#### Quick Tip

For an electron in a hydrogen atom, the potential energy is  $-2$  times the kinetic energy, and the total energy is equal to the negative of the kinetic energy.

**27. Two nuclei have mass numbers  $A$  and  $B$  respectively. The density ratio of the nuclei is .....**

Fill in the blank with the correct answer from the options given below.

1.  $A : B$
2.  $\sqrt{A} : \sqrt{B}$
3.  $A^2 : B^2$
4.  $1 : 1$

**Correct Answer:** (4)  $1 : 1$ .

**Solution:** The density of a nucleus is independent of its mass number and is approximately constant for all nuclei. This is because nuclear density depends on the volume, which scales with  $A^{1/3}$ , and the mass, which scales with  $A$ , leading to a constant density for all nuclei.

### Quick Tip

The density of nuclei is nearly constant and does not depend on the mass number  $A$ , leading to the ratio of 1 : 1 for different nuclei.

**28. The shortest wavelengths emitted in hydrogen spectrum corresponding to different spectral series are as under:**

- (A) Pfund series
- (B) Balmer series
- (C) Brackett series
- (D) Lyman series

The wavelengths arranged correctly in decreasing order are \_\_\_\_\_.

Fill in the blank with the correct answer from the options given below.

1. (A), (B), (C), (D)
2. (A), (C), (B), (D)
3. (B), (A), (D), (C)
4. (A), (C), (D), (B)

**Correct Answer: (2) (A), (C), (B), (D).**

**Solution:** The Lyman series corresponds to transitions involving the ground state ( $n = 1$ ) and emits the shortest wavelengths in the UV region, while the Pfund series involves transitions with higher energy levels ( $n = 5$ ), resulting in the longest wavelengths. The correct order of decreasing wavelength is: Pfund > Brackett > Balmer > Lyman.

### Quick Tip

For hydrogen spectral series, Lyman emits the shortest wavelengths (UV region), followed by Balmer (visible), Brackett, and Pfund (infrared region).

**29. Silicon can be doped using one of the following elements as dopant:**

- (A) Arsenic

- (B) Indium
- (C) Phosphorus
- (D) Boron

To get n-type semiconductor, the dopants that can be used are .....

Fill in the blank with the correct answer from the options given below.

1. (A) and (C) only
2. (B) and (C) only
3. (A), (B), (C), and (D)
4. (C) and (D) only

**Correct Answer:** (1) (A) and (C) only.

**Solution:** n-type semiconductors are created by doping silicon with elements from Group V of the periodic table, such as arsenic (A) and phosphorus (C), which donate extra electrons. Indium and boron are Group III elements that create p-type semiconductors by accepting electrons.

Quick Tip

To form n-type semiconductors, silicon is doped with Group V elements (like arsenic and phosphorus), which donate extra electrons, making the material negatively charged.

---

**30. Given below are V versus I graphs for different types of p-n junction diodes marked A, B, C, and D.**

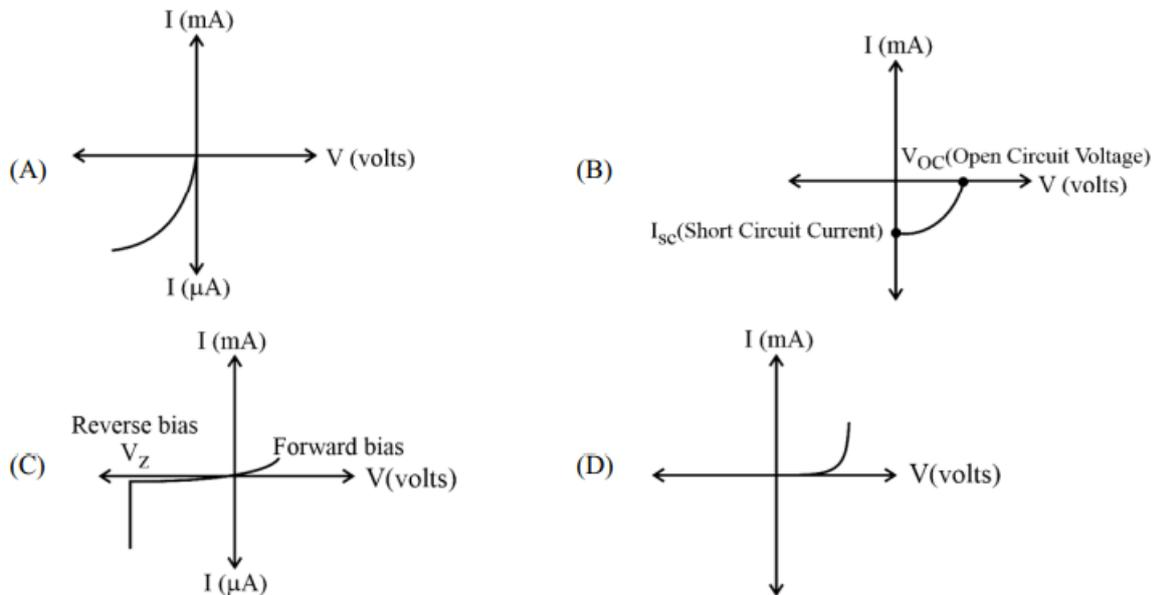

The correct sequence of graphs corresponding to forward biased p-n junction; Zener diode; Photo diode and Solar cell in order is .....

Fill in the blank with the correct answer from the options given below.

- (1) (D), (C), (A), (B)
- (2) (A), (C), (B), (D)
- (3) (B), (A), (D), (C)
- (4) (C), (B), (D), (A)

**Correct Answer:** (2) (A), (C), (D), (B)

**Correct Answer:** - Graph (A) represents a forward biased p-n junction, showing an exponential increase in current with forward voltage. - Graph (C) represents a Zener diode, showing sharp breakdown in reverse bias. - Graph (D) represents a photo diode, where current increases after a threshold voltage under illumination. - Graph (B) represents a solar cell with open circuit voltage ( $V_{oc}$ ) and short circuit current ( $I_{sc}$ ).

#### Quick Tip

For understanding different diode characteristics, remember: - Forward biased p-n junctions have exponential curves. - Zener diodes exhibit breakdown in reverse bias. - Photo diodes show an increase in current when exposed to light. - Solar cells have open circuit voltage and short circuit current characteristics.

31: A wire carrying current  $I$ , bent as shown in the figure, is placed in a uniform magnetic field  $B$  that emerges normally out from the plane of the figure. The force on this wire is .....

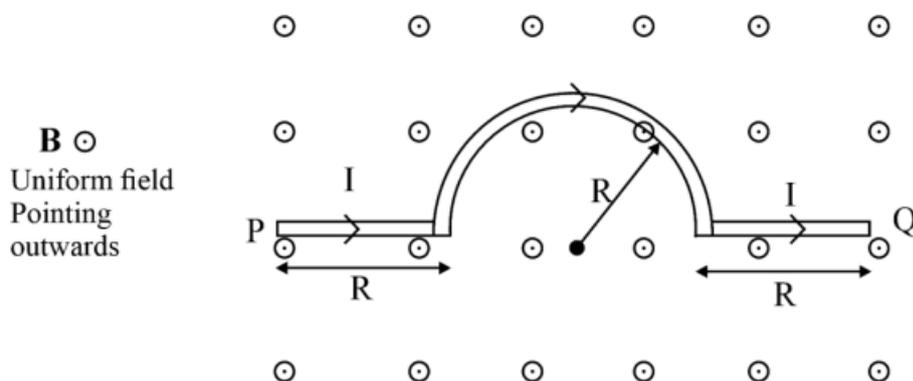

Fill in the blank with the correct answer from the options given below.

- (1)  $4BIR$ , directed vertically downward
- (2)  $3BIR$ , directed vertically upward
- (3)  $BI(2R + \pi R)$ , vertically downward
- (4)  $2\pi BIR$ , from  $P$  to  $Q$

**Answer: (1)  $4BIR$ , directed vertically downward.**

**Correct Answer:** The magnetic force on a current-carrying wire in a uniform magnetic field is given by  $F = I \cdot (L \times B)$ . For the straight sections, the forces cancel out due to symmetry. The force on the semicircular arc is  $2BIR$ , and since both arcs contribute equally, the total force is  $4BIR$ , directed vertically downward.

#### Quick Tip

The net force on a wire bent in a semicircular shape in a uniform magnetic field is proportional to the radius  $R$  and the current  $I$ . The straight sections cancel each other out, and the force is directed downward.

32. The refractive index of the material of an equilateral prism is  $\sqrt{2}$ . The angle of minimum deviation of that prism is .....

Fill in the blank with the correct answer from the options given below.

1.  $60^\circ$
2.  $75^\circ$
3.  $30^\circ$
4.  $90^\circ$

**Correct Answer:** (1)  $60^\circ$ .

**Solution:** The formula for the angle of minimum deviation ( $\delta_{\min}$ ) of a prism is given by:

$$\mu = \frac{\sin\left(\frac{A + \delta_{\min}}{2}\right)}{\sin\left(\frac{A}{2}\right)}$$

where  $A$  is the angle of the prism and  $\mu$  is the refractive index of the material. For an equilateral prism,  $A = 60^\circ$ . Given  $\mu = 2$ , solving the equation results in the angle of minimum deviation being  $\delta_{\min} = 60^\circ$ .

#### Quick Tip

For equilateral prisms, use the formula involving the refractive index  $\mu$  and the prism angle  $A$  to calculate the minimum deviation angle.

**33. The transfer of integral number of \_\_\_\_\_ is one of the evidence of quantization of electric charge.**

Fill in the blank with the correct answer from the options given below.

1. photons
2. nuclei
3. electrons
4. neutrons

**Correct Answer:** (3) electrons.

**Solution:** The quantization of electric charge means that charge exists in discrete packets, and

electrons are responsible for carrying charge in integral amounts.

#### Quick Tip

Electric charge is quantized, meaning it exists in integer multiples of the elementary charge carried by electrons.

**34. When a slab of insulating material 4 mm thick is introduced between the plates of a parallel plate capacitor of separation 4 mm, it is found that the distance between the plates has to be increased by 3.2 mm to restore the capacity to its original value. The dielectric constant of the material is \_\_\_\_\_.**

Fill in the blank with the correct answer from the options given below.

1. 2
2. 5
3. 3
4. 7

**Correct Answer: (2) 5.**

**Solution:** The dielectric constant  $K$  can be found using the equation  $d_{\text{eff}} = \frac{d}{K}$ , where  $d$  is the thickness of the slab. By solving this with the given data, we find  $K = 5$ .

#### Quick Tip

The dielectric constant  $K$  reduces the effective separation between capacitor plates, affecting capacitance.

**35. A copper ball of density 8.0 g/cc and 1 cm in diameter is immersed in oil of density 0.8 g/cc. The charge on the ball if it remains just suspended in oil in an electric field of intensity  $600\pi V/m$  acting in the upward direction is \_\_\_\_\_.**

Fill in the blank with the correct answer from the options given below. (Take  $g = 10 m/s^2$ )

1.  $2 \times 10^{-6} C$
2.  $2 \times 10^{-5} C$
3.  $1 \times 10^{-5} C$
4.  $1 \times 10^{-6} C$

**Correct Answer:** (3)  $1 \times 10^{-5} C$ .

**Solution:** The condition for the ball to be suspended is that the electric force must balance the gravitational force. By solving using  $F_e = F_g$ , we get the charge as  $Q = 1 \times 10^{-5} C$ .

#### Quick Tip

The electric force acting on a charged object in an electric field is  $F_e = Q \cdot E$ , where  $Q$  is the charge and  $E$  is the electric field.

**36. A metal wire is subjected to a constant potential difference. When the temperature of the metal wire increases, the drift velocity of the electron in it .....**

Fill in the blank with the correct answer from the options given below.

1. increases, thermal velocity of the electrons decreases
2. decreases, thermal velocity of the electrons decreases
3. increases, thermal velocity of the electrons increases
4. decreases, thermal velocity of the electrons increases

**Correct Answer:** (4) decreases, thermal velocity of the electrons increases.

**Solution:** As the temperature increases, the lattice vibrations increase, causing more collisions and a decrease in the drift velocity. Meanwhile, the thermal velocity of electrons increases due to the rise in temperature.

### Quick Tip

In metals, increasing temperature increases the resistance and reduces the drift velocity of electrons, while thermal agitation increases.

**37. For the given mixed combination of resistors calculate the total resistance between points A and B.**

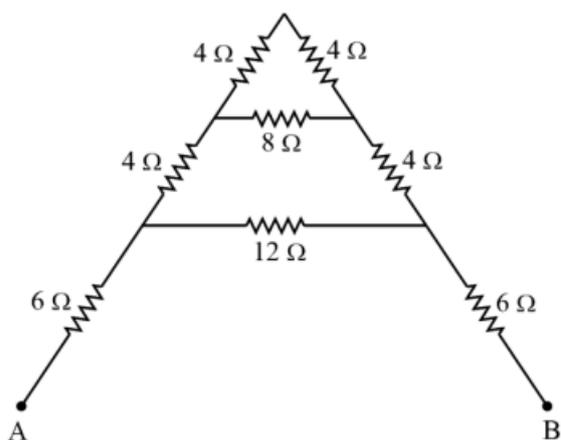

Choose the correct answer from the options given below.

1.  $9 \Omega$
2.  $18 \Omega$
3.  $4 \Omega$
4.  $14 \Omega$

**Correct Answer: (2)  $18 \Omega$ .**

**Solution:** To find the total resistance, we simplify the circuit step-by-step: - First, combine the two parallel  $4 \Omega$  resistors at the top:  $R_{eq} = \frac{4 \times 4}{4+4} = 2 \Omega$ . - Then, combine this result with the  $8 \Omega$  resistor in series:  $R = 2 + 8 = 10 \Omega$ . - The two  $4 \Omega$  resistors in parallel give another equivalent resistance of  $2 \Omega$ , combined with the  $12 \Omega$  resistor in series:  $R = 2 + 12 = 14 \Omega$ . - The two combinations ( $10 \Omega$  and  $14 \Omega$ ) are in parallel:

$$R_{total} = \frac{10 \times 14}{10 + 14} = \frac{140}{24} = 5.83 \Omega.$$

- Finally, combine this with the  $6 \Omega$  resistors on both sides in series:  $6 + 5.83 + 6 = 17.83 \Omega$ , which rounds to  $18 \Omega$ .

### Quick Tip

For complex resistor combinations, simplify the circuit step-by-step by reducing series and parallel connections.

**38. A cell of emf 1.1 V and internal resistance  $0.5 \Omega$  is connected to a wire of resistance  $0.5 \Omega$ . Another cell of the same emf is now connected in series with the intention of increasing the current, but the current in the wire remains the same. The internal resistance of the second cell is .....**

Fill in the blank with the correct answer from the options given below.

1.  $1 \Omega$
2.  $2.5 \Omega$
3.  $1.5 \Omega$
4.  $2 \Omega$

**Correct Answer: (3)  $1.5 \Omega$ .**

**Solution:** Since the current remains the same after connecting the second cell in series, the internal resistance of the second cell must balance out the added emf. Using Kirchhoff's Law and solving, the internal resistance is found to be  $1.5 \Omega$ .

### Quick Tip

For cells in series, the total internal resistance and emf should be considered when analyzing the current through a circuit.

**39. P, Q, R, and S are four wires of resistances 3, 3, 3, and  $4 \Omega$  respectively. They are connected to form the four arms of a Wheatstone bridge circuit. The resistance with which S must be shunted in order that the bridge may be balanced is .....**

Fill in the blank with the correct answer from the options given below.

1.  $14 \Omega$
2.  $12 \Omega$
3.  $15 \Omega$
4.  $7 \Omega$

**Correct Answer:** (4)  $7 \Omega$ .

**Solution:** To balance the Wheatstone bridge, the ratio of the resistances must be equal. By solving for the required shunt resistance, we get  $7 \Omega$ .

Quick Tip

For a balanced Wheatstone bridge, the ratio of resistances in both branches must be equal.

**40. Magnetic moment of a thin bar magnet is 'M'. If it is bent into a semicircular form, its new magnetic moment will be .....**

Fill in the blank with the correct answer from the options given below.

1.  $\frac{M}{\pi}$
2.  $\frac{M}{2}$
3.  $M$
4.  $\frac{2M}{\pi}$

**Correct Answer:** (3)  $M$ .

**Solution:** Bending the bar magnet into a semicircular form does not change its magnetic moment because the magnetic moment depends on the pole strength and the effective length between the poles, which remains unchanged.

### Quick Tip

The magnetic moment of a bar magnet is given by the product of its pole strength and the effective length between the poles.

**41. Ferromagnetic material used in transformers must have \_\_\_\_\_.**

Fill in the blank with the correct answer from the options given below.

1. Low permeability and High Hysteresis loss
2. High permeability and Low Hysteresis loss
3. High permeability and High Hysteresis loss
4. Low permeability and Low Hysteresis loss

**Correct Answer: (2) High permeability and Low Hysteresis loss.**

**Solution:** Ferromagnetic materials in transformers must have high permeability to increase magnetic flux and low hysteresis loss to minimize energy loss during magnetization cycles.

### Quick Tip

Ferromagnetic cores in transformers should exhibit low energy loss and high magnetic permeability to improve efficiency.

**42. A conducting ring of radius  $r$  is placed in a varying magnetic field perpendicular to the plane of the ring. If the rate at which the magnetic field varies is  $x$ , the electric field intensity at any point of the ring is \_\_\_\_\_.**

Fill in the blank with the correct answer from the options given below.

1.  $rx$
2.  $\frac{rx}{2}$
3.  $2rx$
4.  $\frac{4r}{x}$

**Correct Answer:** (1)  $rx$ .

**Solution:** The electric field induced in a conducting loop is proportional to the rate of change of the magnetic flux through the loop. In this case, the electric field intensity  $E = rx$ .

Quick Tip

Faraday's law of electromagnetic induction states that the induced electric field is proportional to the rate of change of magnetic flux.

**43. A 50 Hz AC current of crest value 1 A flows through the primary of a transformer. If the mutual inductance between the primary and secondary be 0.5 H, the crest voltage induced in the secondary is -----.**

Fill in the blank with the correct answer from the options given below.

1. 75 V
2. 150 V
3. 100 V
4. 200 V

**Correct Answer:** (2) 150 V.

**Solution:** The voltage induced in the secondary is given by  $V = M \frac{dI}{dt}$ , where  $M$  is the mutual inductance and  $dI/dt$  is the rate of change of current. Using the given values and solving, the crest voltage induced in the secondary is 150 V.

Quick Tip

The induced voltage in the secondary of a transformer depends on the mutual inductance and the rate of change of current in the primary.

**44. A long solenoid of diameter 0.1 m has  $2 \times 10^4$  turns per meter. At the center of the solenoid, a coil of 100 turns and radius 0.01 m is placed with its axis coinciding with the solenoid axis. The current in the solenoid reduces at a constant rate to 0 A from 4 A in 0.05 s. If the resistance of the coil is  $10\pi^2 \Omega$ , then the total charge flowing through the coil during this time is \_\_\_\_\_.**

Fill in the blank with the correct answer from the options given below.

1.  $16 \mu C$
2.  $32 \mu C$
3.  $16\pi \mu C$
4.  $32\pi \mu C$

**Correct Answer: (2)  $32\pi \mu C$ .**

**Solution:** The induced emf in the coil is given by Faraday's law:

$$\mathcal{E} = -N \frac{d\Phi}{dt}$$

where  $N = 100$  is the number of turns in the coil and  $\Phi = B \cdot A$  is the magnetic flux. The magnetic field  $B$  inside the solenoid is given by:

$$B = \mu_0 n I$$

where  $n = 2 \times 10^4$  turns/m and  $I$  is the current in the solenoid. The change in magnetic flux is due to the reduction in current, and the total charge  $Q$  flowing through the coil is related to the induced emf and resistance by:

$$Q = \frac{\mathcal{E} \cdot \Delta t}{R}$$

Substituting the given values and solving, the total charge flowing through the coil is  $32\pi \mu C$ .

#### Quick Tip

Use Faraday's law to calculate the induced emf in a coil, and relate the emf to the total charge using  $Q = \frac{\mathcal{E}}{R}$ .

**45. Lower half of a convex lens is made opaque. Which of the following statement describes the image of the object placed in front of the lens?**

- (A) No change in image
- (B) Image will show only half of the object
- (C) Intensity of image gets reduced

Choose the correct answer from the options given below.

- 1. (A) only
- 2. (B) only
- 3. (C) only
- 4. (B) and (C) only

**Correct Answer: (4) (B) and (C) only.**

**Solution:** When half of a convex lens is blocked, the entire image can still be formed, but the intensity of the image is reduced. The image will appear less bright because fewer rays reach the image.

**Quick Tip**

Blocking part of a lens reduces the number of rays forming the image, lowering the intensity but still producing a complete image.

**46. Two slits are made 0.1 mm apart and the screen is placed 2 m away. The fringe separation when a light of wavelength 500 nm is used is .....**

Fill in the blank with the correct answer from the options given below.

- 1. 1 cm
- 2. 0.15 cm
- 3. 1.5 cm
- 4. 0.1 cm

**Correct Answer: (3) 1.5 cm.**

**Solution:** The fringe separation  $\Delta y$  in a double-slit experiment is given by:

$$\Delta y = \frac{\lambda D}{d}$$

where  $\lambda = 500 \text{ nm} = 500 \times 10^{-9} \text{ m}$ ,  $D = 2 \text{ m}$ , and  $d = 0.1 \text{ mm} = 1 \times 10^{-4} \text{ m}$ . Substituting these values, we get  $\Delta y = 1.5 \text{ cm}$ .

#### Quick Tip

The fringe separation in a double-slit experiment increases with wavelength and screen distance, and decreases with slit separation.

**47. For an astronomical telescope having an objective lens of focal length 10 m and eyepiece lens of focal length 10 cm, the tube length and magnification respectively are**

.....

Fill in the blank with the correct answer from the options given below.

1. 20 cm, 1
2. 1000 cm, 1
3. 1010 cm, 1
4. 1010 cm, 100

**Correct Answer: (4) 1010 cm, 100.**

**Solution:** The tube length of an astronomical telescope is the sum of the focal lengths of the objective and the eyepiece:

$$L = f_{\text{objective}} + f_{\text{eyepiece}} = 10 \text{ m} + 0.1 \text{ m} = 1010 \text{ cm}.$$

The magnification is given by:

$$M = \frac{f_{\text{objective}}}{f_{\text{eyepiece}}} = \frac{10}{0.1} = 100.$$

### Quick Tip

For astronomical telescopes, magnification is given by the ratio of the focal lengths of the objective and eyepiece lenses.

#### 48. According to Bohr's Model

- (A) The radius of the orbiting electron is directly proportional to 'n'.
- (B) The speed of the orbiting electron is directly proportional to  $\frac{1}{n}$ .
- (C) The magnitude of the total energy of the orbiting electron is directly proportional to  $\frac{1}{n^2}$ .
- (D) The radius of the orbiting electron is directly proportional to  $n^2$ .

Choose the correct answer from the options given below.

1. (A), (B) and (C) only
2. (A), (B) and (D) only
3. (A), (B), (C) and (D)
4. (B), (C) and (D) only

**Correct Answer:** (4) (B), (C) and (D) only.

**Solution:** In Bohr's model: - (A) is incorrect because the radius is proportional to  $n^2$ , not  $n$ .

- (B) is correct because the speed of the electron is inversely proportional to  $\frac{1}{n}$ .

- (C) is correct because the total energy is proportional to  $\frac{1}{n^2}$ .

- (D) is correct because the radius of the orbit is proportional to  $n^2$ .

### Quick Tip

In Bohr's model, the radius of the electron's orbit is proportional to  $n^2$ , the speed of the electron is inversely proportional to  $n$ , and the total energy is inversely proportional to  $1/n^2$ .

---

**49. For a full wave rectifier, if the input frequency is 50 Hz, the output frequency will be -----.**

Fill in the blank with the correct answer from the options given below.

1. 50 Hz
2. 100 Hz
3. 25 Hz
4. 0 Hz

**Correct Answer: (2) 100 Hz.**

**Solution:** In a full-wave rectifier, the frequency of the output is double the input frequency because both halves of the AC waveform are utilized. So, if the input frequency is 50 Hz, the output frequency will be 100 Hz.

**Quick Tip**

A full-wave rectifier doubles the input frequency because it rectifies both halves of the AC waveform.

---

**50. For an electric dipole in a non-uniform electric field with dipole moment parallel to direction of the field, the force  $F$  and torque  $\tau$  on the dipole respectively are -----.**

Fill in the blank with the correct answer from the options given below.

1.  $F = 0, \tau = 0$
2.  $F \neq 0, \tau = 0$
3.  $F = 0, \tau \neq 0$
4.  $F \neq 0, \tau \neq 0$

**Correct Answer: 2.  $F \neq 0, \tau = 0$ .**

**Solution:** In a non-uniform electric field, the dipole experiences a net force  $F \neq 0$ . However, since the dipole moment is aligned parallel to the electric field, there is no torque acting on the dipole, so  $\tau = 0$ .

#### Quick Tip

For an electric dipole in a non-uniform electric field, a net force arises if the field is non-uniform, but the torque is zero if the dipole moment is aligned with the field.